



NZX Rural

- **Accountable**
- **Brave**
- **Leader**
- **Results**
- **Team**
- **Advancing NZ**

Production specs

Country-Wide

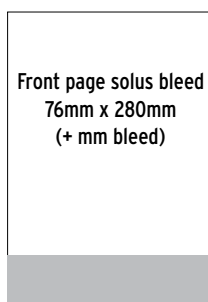
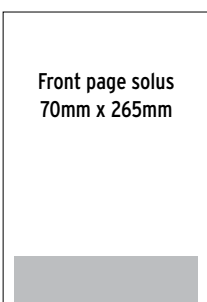
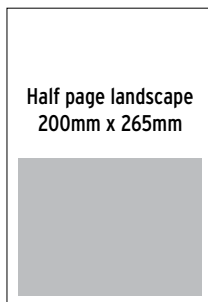
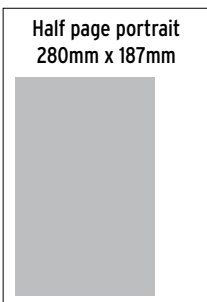
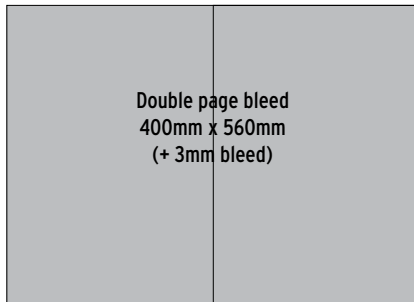
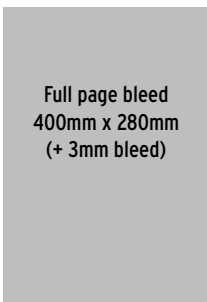
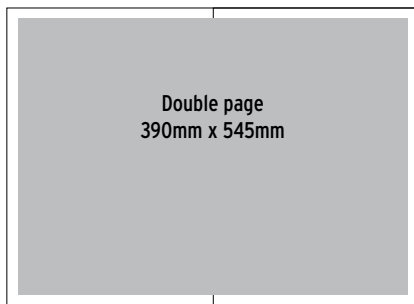
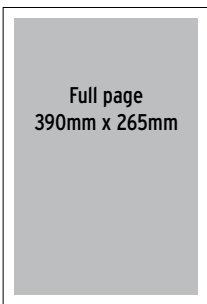

SPECIFICATIONS

depth x width

Full page image size	390mm x 265mm
Full page bleed size	400mm x 280mm (+ 3mm bleed)
Double page image size	390mm x 545mm
Double page bleed size	400mm x 560mm (+ 3mm bleed)
Half page portrait	280mm x 187mm
Half page landscape	200mm x 265mm
Front page solus	70mm x 265mm
Front page solus bleed	76mm x 280mm (+ 3mm bleed)

DISPLAY ADVERTISING

Country-Wide 7 cols per page

Columns	1	2	3	4	5	6	7
(mm)	33	72	110	149	187	226	265

Country-Trader 8 cols per page

Columns	1	2	3	4	5	6	7	8
(mm)	30	63	97	130	164	197	231	265

REAL ESTATE

depth x width

1/8 page	90mm x 130mm
1/4 page vertical	185mm x 130mm
1/4 page horizontal	90mm x 265mm
1/2 page	185mm x 265mm
Full page	390mm x 265mm

PRODUCTION ENQUIRIES

Lana Kieselbach
Production Manager

Ph: 06 323 0735
production@nzx.com

Production specs

THE NEW ZEALAND
Farmers Weekly

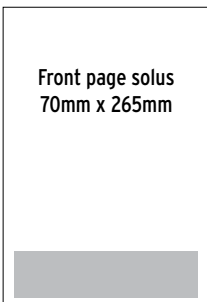
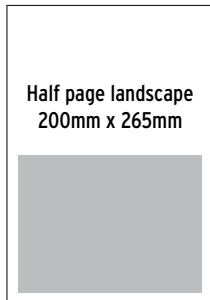
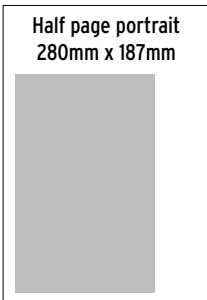
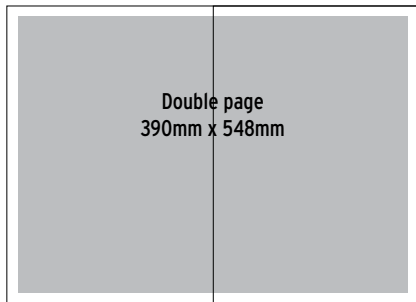
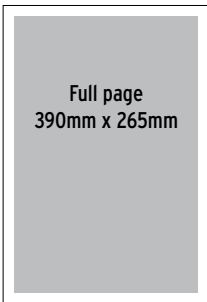

SPECIFICATIONS

depth x width

Full page image size	390mm x 265mm
Double page image size	390mm x 548mm
Half page portrait	280mm x 187mm
Half page landscape	200mm x 265mm
Front page solus	70mm x 265mm

NB: Bleed not accepted for above

Full page wrap/gloss insert 390mm x 548mm

NB: Image area for each page is 390mm x 265mm

Full page wrap with bleed 400mm x 566mm (+ 3mm bleed)

Half page wrap 190mm x 566mm

NB: Image area for each page is 180mm x 265mm

DISPLAY ADVERTISING

Run of paper - 7 cols per page

Columns	1	2	3	4	5	6	7
(mm)	33	72	110	149	187	226	265

Classifieds - 8 cols per page

Columns	1	2	3	4	5	6	7	8
(mm)	30	63	97	130	164	197	231	265

REAL ESTATE

depth x width

1/8 page	90mm x 130mm
1/4 page vertical	185mm x 130mm
1/4 page horizontal	90mm x 265mm
1/2 page	185mm x 265mm
Full page	390mm x 265mm

PRODUCTION ENQUIRIES

Lana Kieselbach
Production Manager

Ph: 06 323 0735
production@nzx.com

Production specs

NEW ZEALAND
DAIRY EXPORTER
NZ's Leading Dairying Magazine

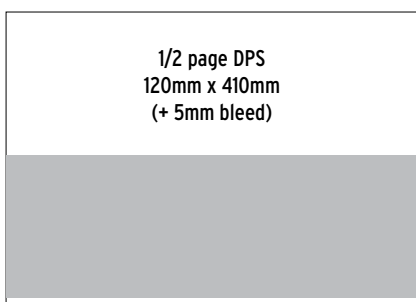
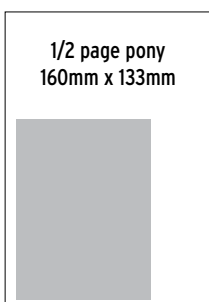
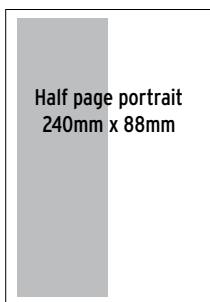
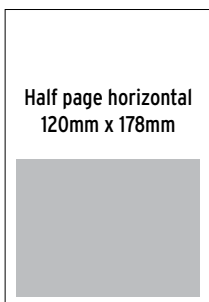
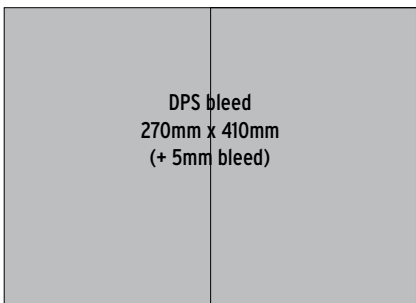
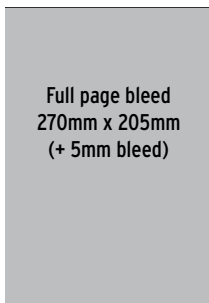
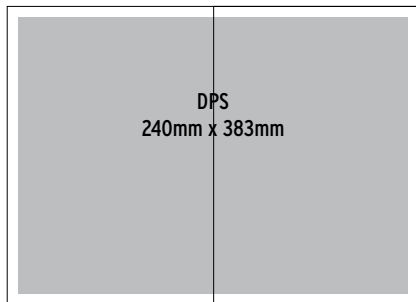

SPECIFICATIONS

	depth x width
Full page	240mm x 178mm
Full page bleed	270mm x 205 (+ 5mm bleed)
DPS	240mm x 383mm
DPS bleed	270mm x 410mm (+ 5mm bleed)
1/2 page horizontal	120mm x 178mm
1/2 page portrait	240mm x 88mm
1/2 page pony	160mm x 133mm
1/2 page DPS (bleed sides only)	120mm x 410mm (+ 5mm bleed)
1/4 page standard	120mm x 88mm
1/4 page portrait	240mm x 42mm
1/4 page horizontal	60mm x 178mm
1/4 page proportional	80mm x 133mm

DISPLAY ADVERTISING

4 cols per page

Columns	1	2	3	4
(mm)	42	88	133	178

BACK Paddock

4 cols per page

1/4 page standard	120mm x 88mm
1/8 page portrait	80mm x 42mm
1/8 page horizontal	50mm x 88mm

PRODUCTION ENQUIRIES

Lana Kieselbach
 Production Manager

Ph: 06 323 0735
production@nzx.com

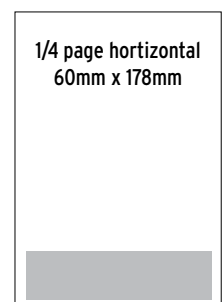
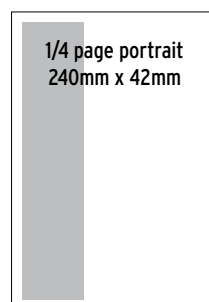
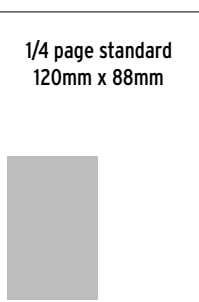

Production specs

**YOUNG
country**

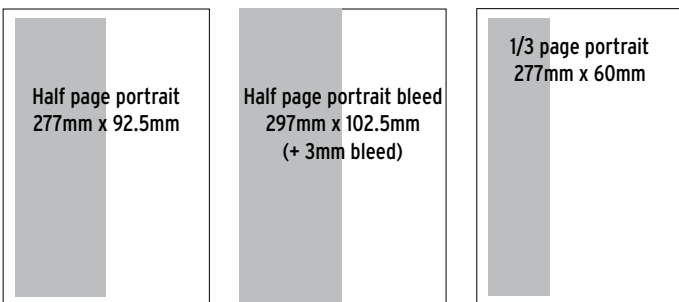
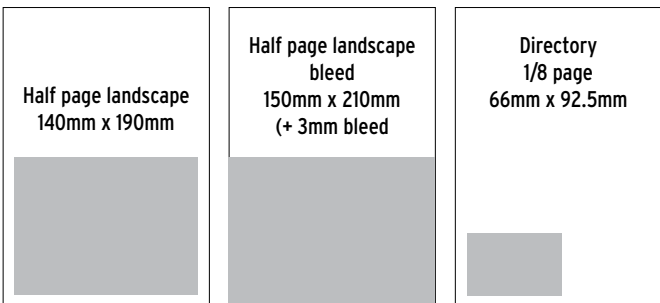
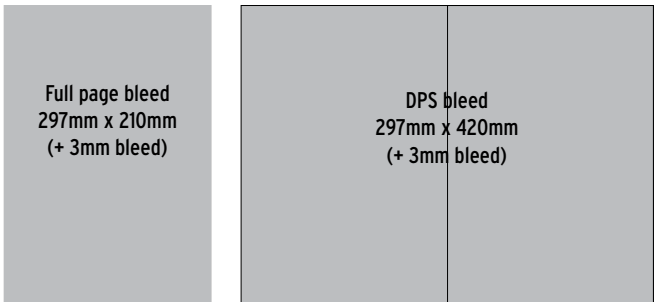
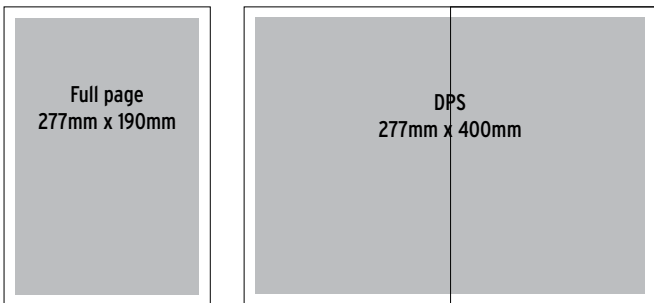

SPECIFICATIONS

depth x width

Full page	277mm x 190mm
Full page bleed	297mm x 210mm (+ 3mm bleed)
DPS	277mm x 400mm
DPS bleed	297mm x 420mm (+ 3mm bleed)
1/2 page landscape	140mm x 190mm
1/2 page landscape bleed	150mm x 210mm (+ 3mm bleed)
1/2 page portrait	277mm x 92.5mm
1/2 page portrait bleed	297mm x 102.5mm (+ 3mm bleed)
1/3 page portrait	277mm x 60mm
1/3 page portrait bleed	297mm x 70mm (+ 3mm bleed)
1/3 page landscape	90mm x 190mm
1/3 page landscape bleed	100mm x 210mm (+ 3mm bleed)
Directory 1/8 page	66mm x 92.5mm

PRODUCTION ENQUIRIES

Lana Kieselbach
Production Manager

Ph: 06 323 0735
production@nzx.com

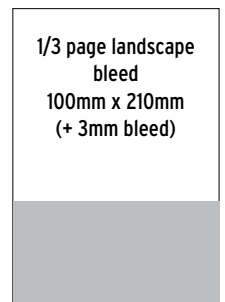
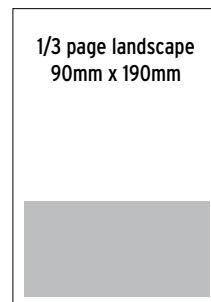
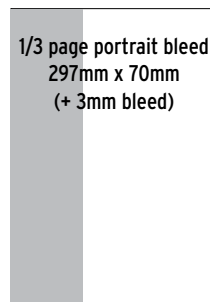

Production specs

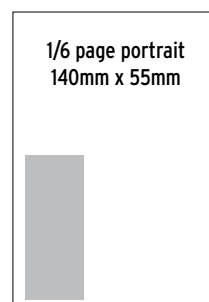
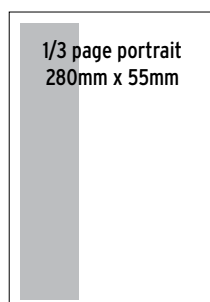
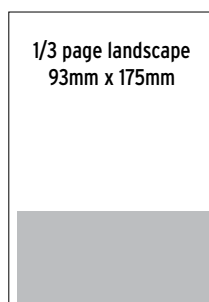
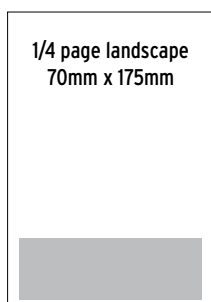
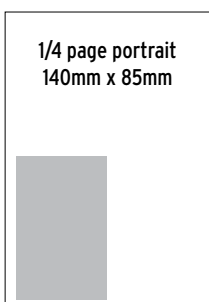
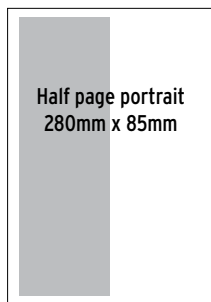
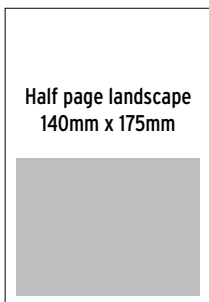
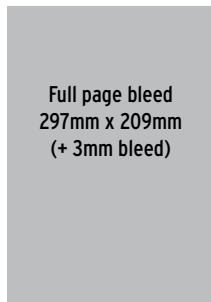
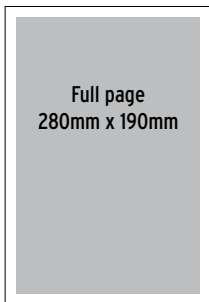
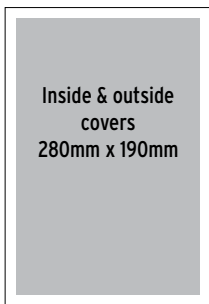

SPECIFICATIONS		depth x width
Inside & outside covers		280mm x 190mm
Inside & outside covers bleed		297mm x 209mm (+ 3mm bleed)
Full page		280mm x 190mm
Full page bleed		297mm x 209mm (+ 3mm bleed)
DPS		280mm x 400mm
DPS bleed		297mm x 420mm (+ 3mm bleed)
Half page DPS		140mm x 400mm
Half page DPS bleed		160mm x 420mm (+ 3mm bleed)
	Landscape	Portrait
1/2 page	140mm x 175mm	280mm x 85mm
1/4 page	70mm x 175mm	140mm x 85mm
1/3 page	93mm x 175mm	280mm x 55mm
1/6 page		140mm x 55mm
Sponsorship adverts		depth x width
70		70mm x 55mm
95		95mm x 55mm
45		45mm x 175mm
30		30mm x 115mm
50		50mm x 115mm

PRODUCTION ENQUIRIES

Lana Kieselbach
Production Manager

Ph: 06 323 0735
production@nzx.com

Website specs

SIZE OPTIONS

Position - top of the page, 2 options:

Large Banner: 760px wide by 120px high

Leaderboard Banner: 760px wide by 90px high

Skyscraper: 160px wide by 600px high

Position - right side of page

Rectangle: 300px wide by 250px high

Position - within page

CONTENT SPECIFICATION

File types accepted: GIFs/JPGs, Flash and HTML.

Animation allowed: Yes.

Maximum file sizes: HTML code must be less than 3Kb. Two (2) images maximum; total file size of images must be less than 20k. Flash animations shall be less than 30Kb.

HTML CREATIVE

All images must be referenced locally (not served from external servers.)

HTML forms must use the "GET" form action (not "POST")

Click-throughs must be targeted to a new window ("_blank")

FLASH CREATIVE

An alternative GIF or JPG must be supplied to serve to users who do not have the Flash plug-in.

The "ClickTAG" must be used in order to track click-throughs. (Hard-coded URLs must not be used.)

```
ClickTag: on (release) {  getURL(_level0.clickTAG,"_blank"); }
```

Note: have to tick the expression box

Click-through URL must be supplied. Click-throughs must be targeted to a new window ("_blank")

Flash must not contain any non-user-initiated audio.

Up to 4 additional streams may load upon User Click. Each additional stream may not exceed 60K

ALL CREATIVE WILL BE REVIEWED AND APPROVED BY NZX RURAL PRIOR TO ACCEPTANCE.

ALL CREATIVE MUST BE SENT TO NICOLA AT nicola@country-wide.co.nz NOT DIRECT TO OUR WEBSITE DEVELOPER.

Material specs

ACCEPTABLE SOFTWARE

Acrobat PDF (preferred option)

High resolution PDFs, preferably using our job options (PDF job options can be supplied to you) otherwise a PRESS OPTIMISED pdf. All links must be high resolution and fonts embedded.

InDesign (up to version CS4)

All text must be converted to outlines and links embedded or supplied. All colour must be CMYK (no spot colours) and links saved as CMYK (not RGB) at 300dpi

Illustrator (up to version CS4)

All text must be converted to curves. All files must be exported as an EPS with all links saved as tifs or jpgs.

Photoshop (up to version CS4)

All supplied images must be saved as grayscale or CMYK and resolution must be at least 300dpi.

Publisher/Powerpoint

These files are NOT suitable for supply prepared adverts and cannot be accepted.

Word

Only suitable for supplying text to go within your advert.

Thank you for supplying digital material to our guidelines. Please also supply an accurate colour proof if possible.

SUPPLY ELECTRONIC MATERIAL TO:

Email	production@country-wide.co.nz
Page Store	We also accept all camera-ready copy through Page Store
FTP	Please contact us for our details

PLEASE CONTACT US IF YOU REQUIRE MORE INFORMATION

Freephone	0800 85 25 80
Direct Dial	06 323 0735
Email	iana@country-wide.co.nz
Fax	06 323 7101
Postal	P0 Box 529, Feilding 4740

